

CONTACTOR, AC-3, 5.5KW/400V, 1NO, DC 24V, 3-POLE, SZ S00
SCREW TERMINAL .



Product brand name	SIRIUS
Product designation	Power contactor
Product type designation	3RT2
General technical data	
Size of contactor	S00
Product extension	
• function module for communication	No
• Auxiliary switch	Yes
Insulation voltage	
• rated value	690 V
Surge voltage resistance rated value	6 kV
maximum permissible voltage for safe isolation	
• between coil and main contacts acc. to EN 60947-1	400 V
Protection class IP	
• on the front	IP20
• of the terminal	IP20
Shock resistance at rectangular impulse	
• at DC	7.3g / 5 ms, 4.7g / 10 ms

Shock resistance with sine pulse	
<ul style="list-style-type: none"> • at DC 	11,4g / 5 ms, 7,3g / 10 ms
Mechanical service life (switching cycles)	
<ul style="list-style-type: none"> • of contactor typical 	30 000 000
<ul style="list-style-type: none"> • of the contactor with added electronics-compatible auxiliary switch block typical 	5 000 000
<ul style="list-style-type: none"> • of the contactor with added auxiliary switch block typical 	10 000 000
Equipment marking	
<ul style="list-style-type: none"> • acc. to DIN 40719 extended according to IEC 204-2 acc. to IEC 750 	K
<ul style="list-style-type: none"> • acc. to DIN EN 61346-2 	Q

Ambient conditions

Installation altitude at height above sea level	
<ul style="list-style-type: none"> • maximum 	2 000 m
Ambient temperature	
<ul style="list-style-type: none"> • during operation 	-25 ... +60 °C
<ul style="list-style-type: none"> • during storage 	-55 ... +80 °C

Main circuit

Number of poles for main current circuit	3
Number of NO contacts for main contacts	3
Operating voltage	
<ul style="list-style-type: none"> • at AC-3 rated value maximum 	690 V
Operating current	
<ul style="list-style-type: none"> • at AC-1 at 400 V <ul style="list-style-type: none"> — at ambient temperature 40 °C rated value 	22 A
<ul style="list-style-type: none"> • at AC-1 <ul style="list-style-type: none"> — up to 690 V at ambient temperature 40 °C rated value 	22 A
<ul style="list-style-type: none"> — up to 690 V at ambient temperature 60 °C rated value 	20 A
<ul style="list-style-type: none"> • at AC-2 at 400 V rated value 	12 A
<ul style="list-style-type: none"> • at AC-3 <ul style="list-style-type: none"> — at 400 V rated value 	12 A
<ul style="list-style-type: none"> — at 500 V rated value 	9.2 A
<ul style="list-style-type: none"> — at 690 V rated value 	6.7 A
Connectable conductor cross-section in main circuit at AC-1	
<ul style="list-style-type: none"> • at 60 °C minimum permissible 	2.5 mm ²
<ul style="list-style-type: none"> • at 40 °C minimum permissible 	4 mm ²
Operating current for approx. 200000 operating cycles at AC-4	

<ul style="list-style-type: none"> • at 400 V rated value • at 690 V rated value 	<p>4.1 A</p> <p>3.3 A</p>
Operating current	
<ul style="list-style-type: none"> • at 1 current path at DC-1 <ul style="list-style-type: none"> — at 24 V rated value — at 110 V rated value — at 220 V rated value — at 440 V rated value — at 600 V rated value • with 2 current paths in series at DC-1 <ul style="list-style-type: none"> — at 24 V rated value — at 110 V rated value — at 220 V rated value — at 440 V rated value — at 600 V rated value • with 3 current paths in series at DC-1 <ul style="list-style-type: none"> — at 24 V rated value — at 110 V rated value — at 220 V rated value — at 440 V rated value — at 600 V rated value 	<p>20 A</p> <p>2.1 A</p> <p>0.8 A</p> <p>0.6 A</p> <p>0.6 A</p> <p>20 A</p> <p>12 A</p> <p>1.6 A</p> <p>0.8 A</p> <p>0.7 A</p> <p>20 A</p> <p>20 A</p> <p>20 A</p> <p>1.3 A</p> <p>1 A</p>
Operating current	
<ul style="list-style-type: none"> • at 1 current path at DC-3 at DC-5 <ul style="list-style-type: none"> — at 24 V rated value — at 110 V rated value • with 2 current paths in series at DC-3 at DC-5 <ul style="list-style-type: none"> — at 24 V rated value — at 110 V rated value • with 3 current paths in series at DC-3 at DC-5 <ul style="list-style-type: none"> — at 24 V rated value — at 110 V rated value — at 220 V rated value — at 440 V rated value — at 600 V rated value 	<p>20 A</p> <p>0.1 A</p> <p>20 A</p> <p>0.35 A</p> <p>20 A</p> <p>20 A</p> <p>1.5 A</p> <p>0.2 A</p> <p>0.2 A</p>
Operating power	
<ul style="list-style-type: none"> • at AC-1 <ul style="list-style-type: none"> — at 230 V rated value — at 230 V at 60 °C rated value — at 400 V rated value — at 400 V at 60 °C rated value — at 690 V rated value 	<p>7.5 kW</p> <p>7.5 kW</p> <p>13 kW</p> <p>13 kW</p> <p>22 kW</p>

<ul style="list-style-type: none"> — at 690 V at 60 °C rated value 	22 kW
<ul style="list-style-type: none"> • at AC-2 at 400 V rated value 	5.5 kW
<ul style="list-style-type: none"> • at AC-3 <ul style="list-style-type: none"> — at 230 V rated value — at 400 V rated value — at 500 V rated value — at 690 V rated value 	3 kW 5.5 kW 5.5 kW 5.5 kW
Operating power for approx. 200000 operating cycles at AC-4	
<ul style="list-style-type: none"> • at 400 V rated value • at 690 V rated value 	2 kW 2.5 kW
Thermal short-time current limited to 10 s	90 A
Power loss [W] at AC-3 at 400 V for rated value of the operating current per conductor	1.2 W
No-load switching frequency	
<ul style="list-style-type: none"> • at DC 	10 000 1/h
Operating frequency	
<ul style="list-style-type: none"> • at AC-1 maximum • at AC-2 maximum • at AC-3 maximum • at AC-4 maximum 	1 000 1/h 750 1/h 750 1/h 250 1/h

Control circuit/ Control

Type of voltage of the control supply voltage	DC
Control supply voltage at DC	
<ul style="list-style-type: none"> • rated value 	24 V
Operating range factor control supply voltage rated value of magnet coil at DC	
<ul style="list-style-type: none"> • initial value • Full-scale value 	0.8 1.1
Closing power of magnet coil at DC	4 W
Holding power of magnet coil at DC	4 W
Closing delay	
<ul style="list-style-type: none"> • at DC 	30 ... 100 ms
Opening delay	
<ul style="list-style-type: none"> • at DC 	7 ... 13 ms
Arcing time	10 ... 15 ms
Control version of the switch operating mechanism	Standard A1 - A2
Residual current of the electronics for control with signal <0>	
<ul style="list-style-type: none"> • at AC at 230 V maximum permissible • at DC at 24 V maximum permissible 	4 mA 10 mA

Auxiliary circuit

Number of NO contacts	
<ul style="list-style-type: none"> • for auxiliary contacts <ul style="list-style-type: none"> — instantaneous contact 	1
Operating current at AC-12 maximum	10 A
Operating current at AC-15	
<ul style="list-style-type: none"> • at 230 V rated value • at 400 V rated value • at 500 V rated value • at 690 V rated value 	10 A 3 A 2 A 1 A
Operating current at DC-12	
<ul style="list-style-type: none"> • at 24 V rated value • at 48 V rated value • at 60 V rated value • at 110 V rated value • at 125 V rated value • at 220 V rated value • at 600 V rated value 	10 A 6 A 6 A 3 A 2 A 1 A 0.15 A
Operating current at DC-13	
<ul style="list-style-type: none"> • at 24 V rated value • at 48 V rated value • at 60 V rated value • at 110 V rated value • at 125 V rated value • at 220 V rated value • at 600 V rated value 	10 A 2 A 2 A 1 A 0.9 A 0.3 A 0.1 A
Contact reliability of auxiliary contacts	1 faulty switching per 100 million (17 V, 1 mA)

UL/CSA ratings

Full-load current (FLA) for three-phase AC motor	
<ul style="list-style-type: none"> • at 480 V rated value • at 600 V rated value 	11 A 11 A
Yielded mechanical performance [hp]	
<ul style="list-style-type: none"> • for single-phase AC motor <ul style="list-style-type: none"> — at 110/120 V rated value — at 230 V rated value • for three-phase AC motor <ul style="list-style-type: none"> — at 200/208 V rated value — at 220/230 V rated value — at 460/480 V rated value — at 575/600 V rated value 	0.5 hp 2 hp 3 hp 3 hp 7.5 hp 10 hp
Contact rating of auxiliary contacts according to UL	A600 / Q600

Short-circuit protection

Design of the fuse link <ul style="list-style-type: none"> • for short-circuit protection of the main circuit <ul style="list-style-type: none"> — with type of coordination 1 required — with type of assignment 2 required • for short-circuit protection of the auxiliary switch required 	gG NH 3NA, DIAZED 5SB, NEOZED 5SE: 50 A gG NH 3NA, DIAZED 5SB, NEOZED 5SE: 25 A fuse gG: 10 A
--	---





Installation/ mounting/ dimensions	
Mounting position	+/-180° rotation possible on vertical mounting surface; can be tilted forward and backward by +/- 22.5° on vertical mounting surface
Mounting type <ul style="list-style-type: none"> • Side-by-side mounting 	screw and snap-on mounting onto 35 mm standard mounting rail according to DIN EN 60715 Yes
Height	58 mm
Width	45 mm
Depth	73 mm
Required spacing <ul style="list-style-type: none"> • for grounded parts <ul style="list-style-type: none"> — at the side • for live parts <ul style="list-style-type: none"> — at the side 	6 mm 6 mm



Connections/Terminals	
Type of electrical connection <ul style="list-style-type: none"> • for main current circuit • for auxiliary and control current circuit 	screw-type terminals screw-type terminals
Type of connectable conductor cross-sections <ul style="list-style-type: none"> • for main contacts <ul style="list-style-type: none"> — solid — single or multi-stranded — finely stranded with core end processing • at AWG conductors for main contacts 	2x (0.5 ... 1.5 mm ²), 2x (0.75 ... 2.5 mm ²), 2x 4 mm ² 2x (0,5 ... 1,5 mm ²), 2x (0,75 ... 2,5 mm ²), 2x 4 mm ² 2x (0.5 ... 1.5 mm ²), 2x (0.75 ... 2.5 mm ²) 2x (20 ... 16), 2x (18 ... 14), 2x 12
Connectable conductor cross-section for main contacts <ul style="list-style-type: none"> • solid • stranded 	0.5 ... 4 mm ² 0.5 ... 4 mm ²
Type of connectable conductor cross-sections <ul style="list-style-type: none"> • for auxiliary contacts <ul style="list-style-type: none"> — single or multi-stranded — finely stranded with core end processing • at AWG conductors for auxiliary contacts 	2x (0,5 ... 1,5 mm ²), 2x (0,75 ... 2,5 mm ²), 2x 4 mm ² 2x (0.5 ... 1.5 mm ²), 2x (0.75 ... 2.5 mm ²) 2x (20 ... 16), 2x (18 ... 14), 2x 12

Safety related data	
B10 value	

• with high demand rate acc. to SN 31920	1 000 000
Proportion of dangerous failures	
• with low demand rate acc. to SN 31920	40 %
• with high demand rate acc. to SN 31920	73 %
Failure rate [FIT]	
• with low demand rate acc. to SN 31920	100 FIT
Product function	
• Mirror contact acc. to IEC 60947-4-1	Yes; with 3RH29
T1 value for proof test interval or service life acc. to IEC 61508	20 y
Protection against electrical shock	finger-safe

Certificates/approvals

General Product Approval	Functional Safety/Safety of Machinery
 CCC	 CSA
 UL	 EAC
	KC Type Examination

Declaration of Conformity	Test Certificates	Marine / Shipping
 EG-Konf.	Type Test Certificates/Test Report Special Test Certificate Miscellaneous	 ABS
		 BUREAU VERITAS

Marine / Shipping

 GL	 LRS	 PRS	 RINA	 RMRS	 DNV-GL
---	--	--	---	---	---

other

[Confirmation](#)



VDE

Further information

Information- and Downloadcenter (Catalogs, Brochures,...)
<http://www.siemens.com/industrial-controls/catalogs>

Industry Mall (Online ordering system)

<https://mall.industry.siemens.com/mall/en/en/Catalog/product?mlfb=3RT2017-1BB41>

Cax online generator

<http://support.automation.siemens.com/WW/CAXorder/default.aspx?lang=en&mlfb=3RT2017-1BB41>

Service&Support (Manuals, Certificates, Characteristics, FAQs,...)

<https://support.industry.siemens.com/cs/ww/en/ps/3RT2017-1BB41>

Image database (product images, 2D dimension drawings, 3D models, device circuit diagrams, EPLAN macros, ...)

http://www.automation.siemens.com/bilddb/cax_de.aspx?mlfb=3RT2017-1BB41&lang=en

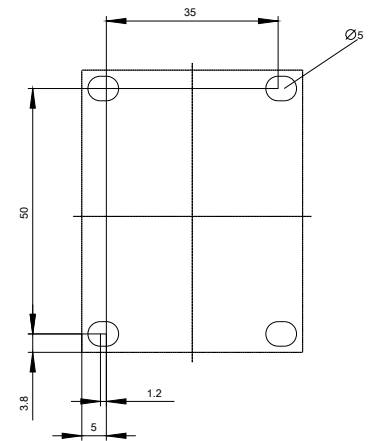
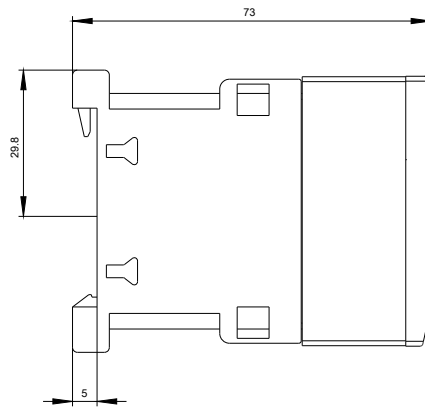
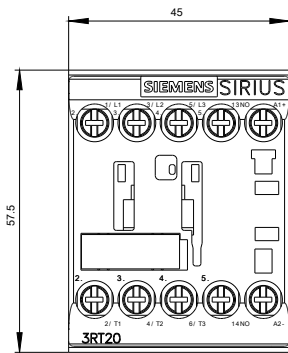

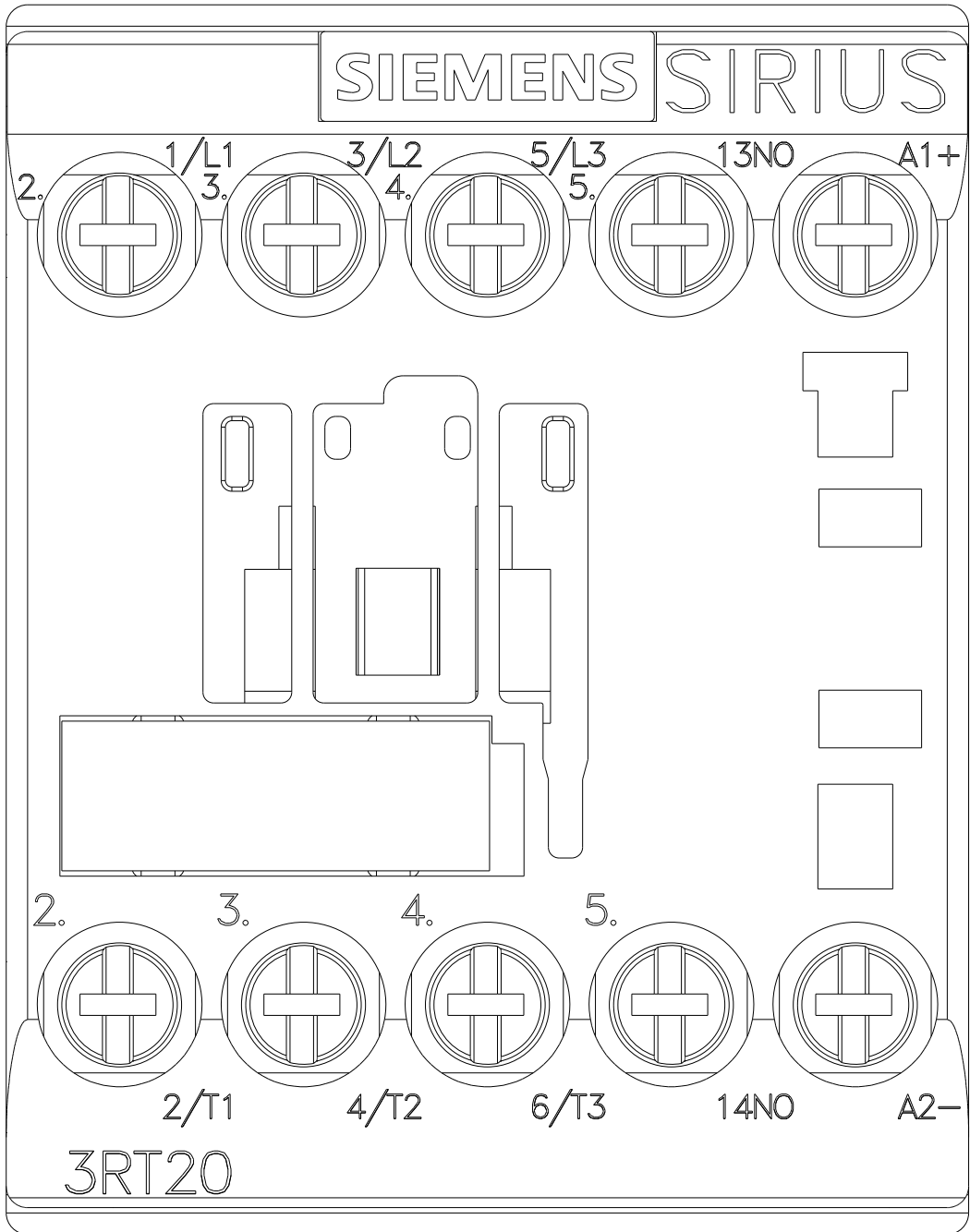

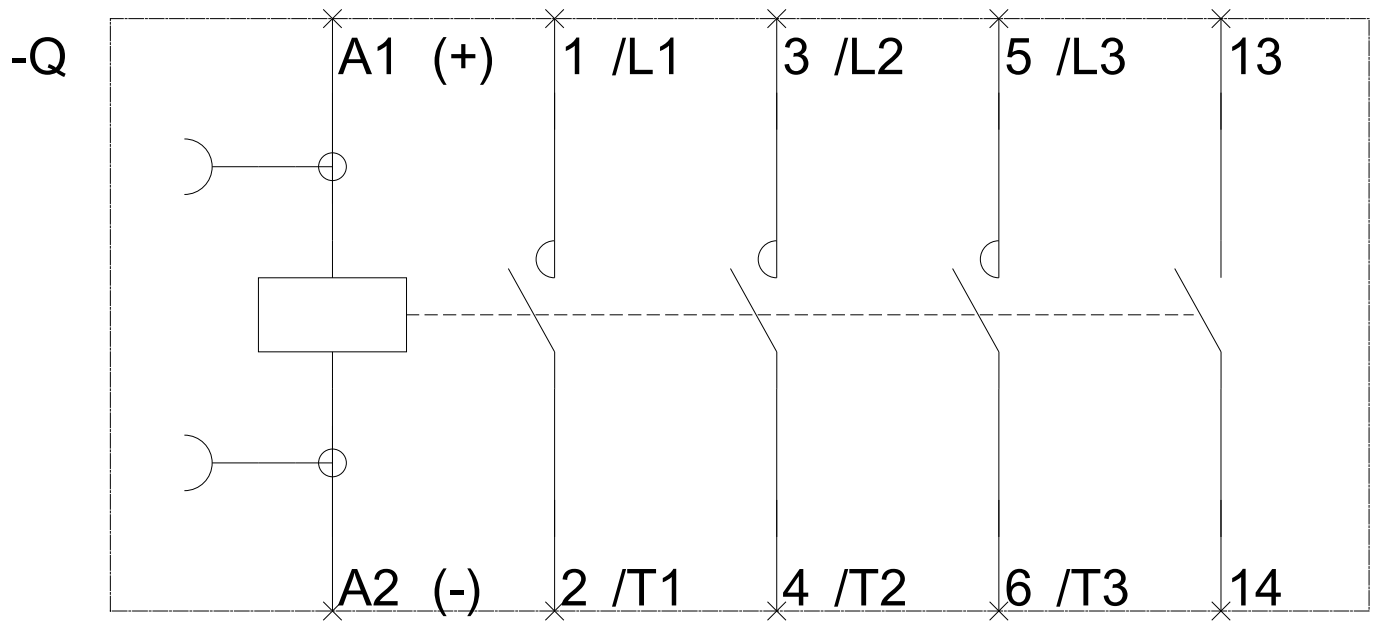

last modified:

11/26/2017